

**Contents:**

**GROUP 15 - 15.1 - Router Bits**

**15.2 - Drill Bits / Saw Blades / Accessories**

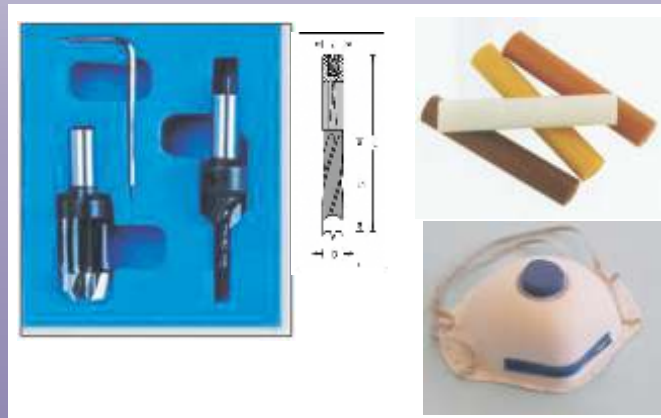

www.tekform.com.au

>Router Bits

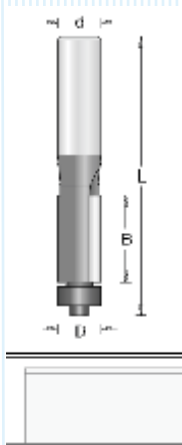

Stock Code	Description	Unit
WT60400	Flush Trimming Bit 12.7mm Dia x 20mm Cut Length x 1/4" Shank	Each
WT60401	Replacement Knives	Each

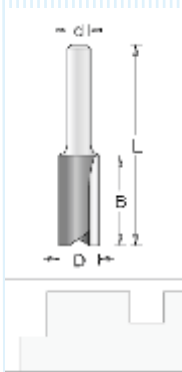

Stock Code	Description	Unit
WT60405	Straight Bit 12mm Dia x 23mm Cut Length x 1/4" Shank	Each
WT60406	Replacement Knives	Each

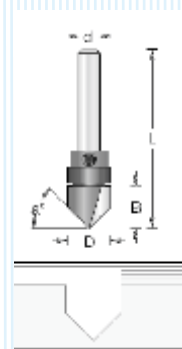

Stock Code	Description	Unit
WT60410	FV Grooving Bit 17.6mm Dia x 30mm Cut Length x 1/4" Shank	Each
WT60411	Replacement Knives	Each

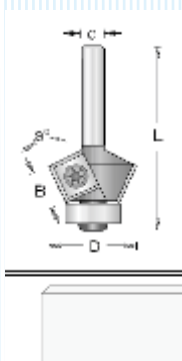

Stock Code	Description	Unit
WT60415	Bevel Trimming Bit 27.3mm Dia x 45° x 1/4" Shank	Each
WT60416	Replacement Knives	Each

Router Bits

Group 15  
15.1

www.tekform.com.au

>Router Bits

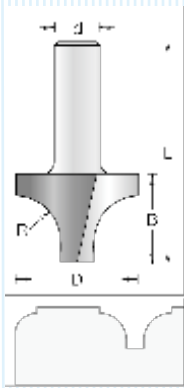

Stock Code	Description	Unit
WT60420	Rounding Over Bit 26mm Dia x 6mm Rad 1/4" Shank	Each
WT60421	Replacement Knives	Each

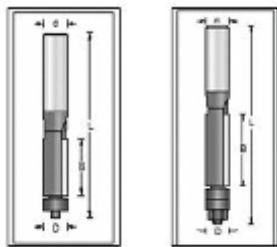

Stock Code	Description	Flutes	D	B	L	Dia	Unit
WT60500	Flush Trimmer Bit	2	6.35	25.4	67.0	6.35	Each
WT60501	Flush Trimmer Bit	2	12.7	25.4	67.0	6.35	Each
WT60502	Flush Trimmer Bit	2	12.7	38.1	98.0	12.7	Each
WT60503	Flush Trimmer Bit	2	12.7	51.0	116.7	12.7	Each

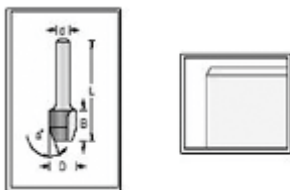

Stock Code	Description	Angle	D	B	L	Dia	Unit
WT60510	Combi Trimmer Bit - Flush & Bevel	23	9.5	12.7	41.3	6.35	Each
WT60511	Combi Trimmer Bit - Flush & Bevel	30	12.7	25.4	67.0	6.35	Each

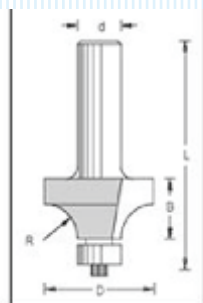

Stock Code	Description	Radius	D	B	L	Dia	Unit
WT60515	Rounding - Over Bit	6.35	25.4	12.7	51.0	6.35	Each
WT60516	Rounding - Over Bit	12.7	38.1	19.1	57.0	6.35	Each
WT60517	Rounding - Over Bit	9.5	31.8	15.9	57.0	12.7	Each
WT60518	Rounding - Over Bit	15.9	44.5	22.2	71.0	12.7	Each

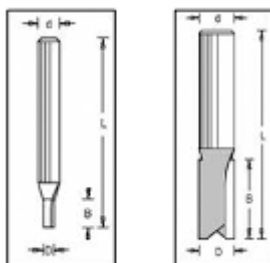

Stock Code	Description	D	B	L	Dia	Unit
WT60520	Straight Bit - Double Fluted	1/8"	7/16"	2"	1/4"	Each
WT60521	Straight Bit - Double Fluted	1/4"	1"	2 7/8"	1/4"	Each
WT60522	Straight Bit - Double Fluted	3/8"	1 1/4"	2 1/4"	1/4"	Each
WT60523	Straight Bit - Double Fluted	1/2"	2"	4 1/4"	1/2"	Each



Stock Code	Description	Dia	D	Unit
WT60530	Click & Drill (Quick Change System) 3 Counter Sunks + 1 Chuck			Each <sup>Group 15</sup> <b>15.1</b>
WT60531	Click & Drill (Quick Change System) "7 pce set"	2.5"	9.5"	Each
WT60532	Click & Drill (Quick Change System) "7 pce set"	3.2"	9.5"	Each
WT60533	Click & Drill (Quick Change System) "7 pce set"	4.0"	9.5"	Each

Router Bits

www.tekform.com.au

> Drill Bits / Saw Blades / Accessories

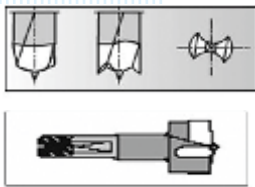

Stock Code	Description	D	L	Dia	Unit
WT60540	Dowel Drills/Hinge Boring Bits R/H Black	5.0	57.5	10	Each
WT60541	Dowel Drills/Hinge Boring Bits L/H Orange	5.0	57.5	10	Each
WT60546	Dowel Drills/Hinge Boring Bits R/H Black	8.0	57.5	10	Each
WT60547	Dowel Drills/Hinge Boring Bits L/H Orange	8.0	57.5	10	Each
WT60550	Dowel Drills/Hinge Boring Bits R/H Black	10.0	57.5	10	Each
WT60551	Dowel Drills/Hinge Boring Bits L/H Orange	10.0	57.5	10	Each
WT60560	Dowel Drills/Hinge Boring Bits R/H Black	35.0	57.5	10	Each



Stock Code	Description	Unit
WT80695	Mag Holder 1/4"	Each



Stock Code	Description	Unit
WT80600	Phillips Bit 25mm PH1	Each
WT80605	Phillips Bit 25mm PH2	Each
WT80625	Pozi Bit 25mm PZ2	Each



Stock Code	Description	Unit
WT80610	Phillips Bit 50mm PH1	Each
WT80615	Phillips Bit 50mm PH2	Each
WT80630	Pozi Bit 50mm PZ2	Each

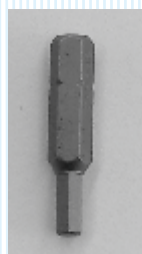

Stock Code	Description	Unit
WT80675	Hex Bit 25mm x 3mm	Each
WT80680	Hex Bit 25mm x 4mm	Each
WT80685	Hex Bit 50mm x 3mm	Each
WT80690	Hex Bit 50mm x 4mm	Each
WT80692	Hex Bit 50mm x 5mm	Each

Group 15  
**15.2**

Drill Bits / Saw Blades / Accessories

www.tekform.com.au

> Drill Bits / Saw Blades / Accessories

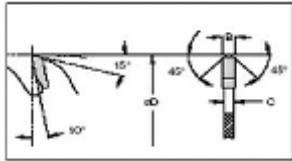

Stock Code	Description	Unit
WT60100	D-Max Saw Blades - Triple Chip 300mm Dia x 96 Teeth x 30mm Bore x 3.2kcrf	Each
WT60105	D-Max Saw Blades - Triple Chip 300mm Dia x 72 Teeth x 30mm Bore x 3.2kcrf	Each
WT60110	D-Max Saw Blades - Alternate Top Bevel 300mm Dia x 96 Teeth x 30mm Bore x 3.2kcrf	Each
WT60115	D-Max Saw Blades - Alternate Top Bevel 300mm Dia x 72 Teeth x 30mm Bore x 3.2kcrf	Each
WT60120	D-Max Saw Blades - Alternate Top Bevel 350mm Dia x 54 Teeth x 30mm Bore x 3.2kcrf	Each
WT60200	D-Max Saw Blades - NOVA - Split Scribes 120mm Dia x 2/12 Teeth x 20mm & 22mm Bore	Each
WT60205	D-Max Saw Blades - NOVA - Split Scribes 125mm Dia x 2/12 Teeth x 20mm & 22mm Bores	Each
WT60210	D-Max Saw Blades - NOVA - Split Scribes 125mm Dia x 2/12 Teeth x 50mm Bore - Altendorf	Each
WT60220	Complete Unit - NOVA - Split Scribes 120mm Dia x 2/12 Teeth x 20mm & 22mm Bore	Each

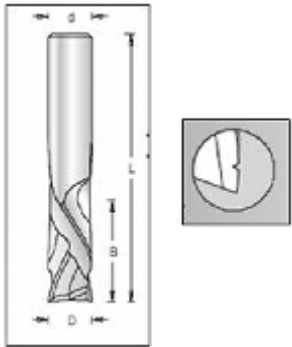

Stock Code	Description	Unit
WT60300	Vortex - Solid Carbide Compression Cutters 2 Flutes 9.5mm Dia x 30mm Cut Length x 9.5mm Shank Z2	Each
WT60305	Vortex - Solid Carbide Compression Cutters 2 Flutes 10mm Dia x 30mm Cut Length x 10mm Shank Z2	Each
WT60310	Vortex - Solid Carbide Compression Cutters 3 Flutes 9.5mm Dia x 30mm Cut Length x 9.5mm Shank Z3	Each
WT60315	Vortex - Solid Carbide Compression Cutters 3 Flutes 10mm Dia x 30mm Cut Length x 10mm Shank Z2	Each

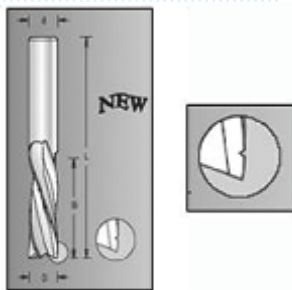

Stock Code	Description	Unit
WT60350	Solid Carbide Spiral Cutters (Up or Down Spiral) 8mm Dia x 22mm Cut Length x 8mm Shank Z2	Each
WT60355	Solid Carbide Spiral Cutters (Up or Down Spiral) 12.7mm Dia x 42mm Cut Length x 12.7mm Shank Z3	Each

Drill Bits / Saw Blades / Accessories

Group 15  
**15.2**

> Drill Bits / Saw Blades / Accessories

	Stock Code	Description	Unit
	WT80027	Jigsaw Blade T101 B - 5 Pack To Suit Bosch, AEG, Makita, ELU Upward Cut, Fine	Each
			

	Stock Code	Description	Unit
	WT80028	Jigsaw Blade T101 BR - 5 Pack To Suit Bosch, AEG, Makita, ELU Downward Cut, Fine	Each
			

	Stock Code	Description	Unit
	WT80029	Jigsaw Blade T101 D - 5 Pack To Suit Bosch, AEG, Makita, ELU Upward Cut, Coarse	Each
			

	Stock Code	Description	Unit
	WT80036	Jigsaw Blade T144 D - 5 Pack To Suit Bosch, AEG, Makita, ELU Upward Cut, Coarse	Each
			
			

Drill Bits / Saw Blades / Accessories

Group 15  
**15.2**

www.tekform.com.au

> Drill Bits / Saw Blades / Accessories

	Stock Code	Description	Unit
	WT80041	Makita Jigsaw Blade B10 - 5 Pack To Suit Bosch, AEG, Makita, ELU Upward Cut, Coarse	Each
			

	Stock Code	Description	Unit
	WT80011	Planer Blades Reversible - 2 Pack Cutting Width 82mm	Each

	Stock Code	Description	Unit
	WT30034	Repair Crayon Black	Each
	WT30037	Repair Crayon White	Each
	WT30038	Repair Crayon New Ant White	Each
	WT30039	Repair Crayon Baltic Pines	Each
	WT30040	Repair Crayon Birch	Each
	WT30041	Repair Crayon Cherry	Each
	WT30042	Repair Crayon Dark Walnut	Each
	WT30043	Repair Crayon Folkstone	Each
	WT30044	Repair Crayon Gunmetal	Each
	WT30045	Repair Crayon Ironstone	Each
	WT30046	Repair Crayon Jarrah	Each
	WT30047	Repair Crayon Light Teak	Each
	WT30048	Repair Crayon Marl Beige	Each
	WT30049	Repair Crayon Parchment	Each
	WT30050	Repair Crayon Red Cherry	Each
	WT30051	Repair Crayon Select Beech	Each
WT30052	Repair Crayon Teak	Each	
WT30053	Repair Crayon Tasmanian Oak	Each	
WT30054	Repair Crayon Wild Birch	Each	
WT30055	Repair Crayon Walnut	Each	
WT30056	Repair Crayon Young Beech	Each	

Drill Bits / Saw Blades / Accessories

Group 15  
**15.2**

[www.tekform.com.au](http://www.tekform.com.au)

> Drill Bits / Saw Blades / Accessories

	Stock Code	Description	Unit
	WT82380	Nuisance Dusk Mask	Each

	Stock Code	Description	Unit
	WT82382	P2 Respirators W/Value	Each

	Stock Code	Description	Unit
	WT82501	Muti 10 Pack	Each

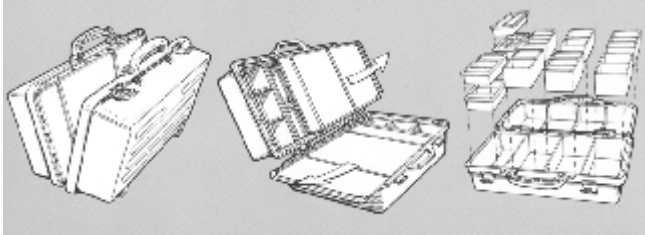

	Stock Code	Description	Unit
 <small>Made in Australia</small>	WT82500	Exactapak	Each

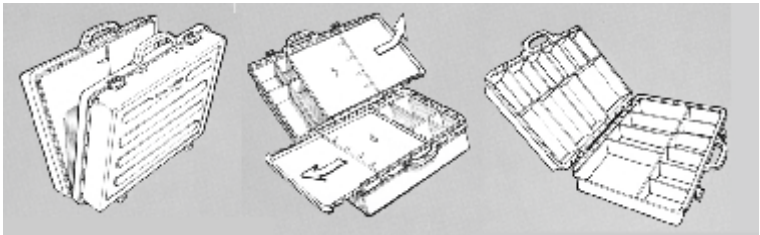

Drill Bits / Saw Blades / Accessories

Group 15  
**15.2**

