

Contents:

GROUP 3 - 3.1 - Catches

3.2 - Bed fittings & Corner Brackets

3.3 - Bump-ons

3.4 - Connectors, Cable Caps & Castors

3.5 - Fittings General

3.6 - Shelf Supports

3.7 - Sliding Door Tracks



>Catches



Stock Code	Description	Unit
IF65475	Corna Support Catch - Side Mount	Each

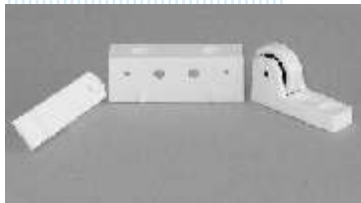

Stock Code	Description	Unit
IF65480	Corna Support Catch - Top Mount	Each



Stock Code	Description	Unit
IF65470	Daisy Catch DSY-3	Each



Stock Code	Description	Unit
IF65570	Catch Gripper Nylon	Each



Stock Code	Description	Unit
IF65585	Catch Magnetic Brown 6KG 2H Striker Plate	Each
IF65590	Catch Magnetic White 6KG 2H Striker Plate	Each

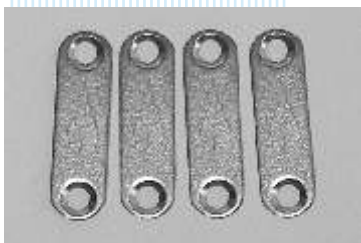

Stock Code	Description	Unit
IF65605	Striker Plate 2 Hole	Each

www.tekform.com.au

>Catches



Stock Code	Description	Unit
IF65610	Catch Audio. Push Single	Each
IF65615	Catch Audio. Push Double	Each



Stock Code	Description	Unit
IF65620	Catch Strike Plate Hook ST418	Each



Stock Code	Description	Unit
IF65625	Catch Strike Plate Black ST419	Each



Stock Code	Description	Unit
IF65640	Catch Roller Zinc	Each



Stock Code	Description	Unit
IF65650	Catch Touch Mini White	Each
IF65655	Catch Touch Mini Brown	Each





Stock Code	Description	Unit
IF65770	Door Stop Plastic DS1 White - 2 Parts = 1 Clip + 1 Stop	Each

Catches
Group 3
3.1

>Bed Fittings & Corner Brackets

	Stock Code	Description	Unit
	IF65004	Bed Fitting #1190 Water Bed YZ	Each

	Stock Code	Description	Unit
	IF65006	Bed Fitting #1191 Centre Rail	Each

	Stock Code	Description	Unit
	IF65010	Bed Bracket Maxi/Lock 90mm YZ	Each

	Stock Code	Description	Unit
	IF65012	Bed Bracket Maxi/Lock 120mm YZ	Each

	Stock Code	Description	Unit
	IF65100	Bracket Corner Leg ZP No:1060	Each

	Stock Code	Description	Unit
	IF65105	Bracket Corner Leg ZP No:1061	Each

>Bed Fittings & Corner Brackets

	Stock Code	Description	Unit
	IF65107	Bracket Corner Leg ZP No:1074	Each

	Stock Code	Description	Unit
	IF65115	Bracket Corner SYS32 #1090 ZP	Each

	Stock Code	Description	Unit
	IF65120	Bracket Corner 25mm x 25mm	Each

	Stock Code	Description	Unit
	IF65125	Bracket Corner 38mm x 38mm	Each

	Stock Code	Description	Unit
	IF65130	Bracket Corner 50mm x 50mm	Each

>Bed Fittings & Corner Brackets

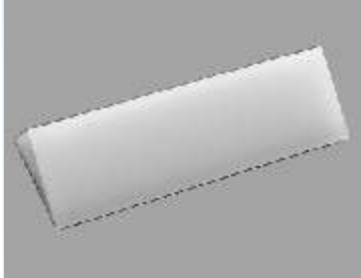
	Stock Code	Description	Unit
	IF65680	Corner Block Natural 60x20mm	Each

	Stock Code	Description	Unit
	IF65685	Corner Block Natural 45x20mm	Each

	Stock Code	Description	Unit
	IF65690	Corner Glide Protector White	Each

	Stock Code	Description	Unit
	IF65695	Corner Protect Plastic Open 45deg	Each

www.tekform.com.au

>Bump-ons

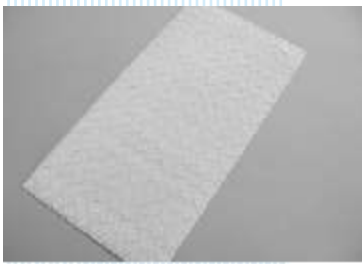

Stock Code	Description	Unit
IF65200	Bump-on Bs-5 Clear 12.7x1.5mm 200 pieces per sheet	Each

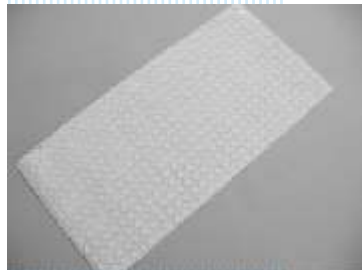

Stock Code	Description	Unit
IF65205	Bump-on Bs-7 Clear 8.5x2.2mm 450 pieces per sheet	Each

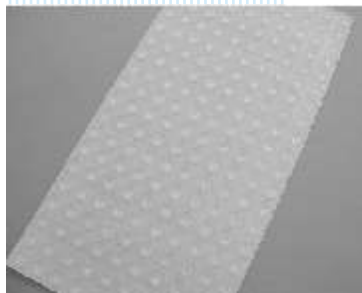

Stock Code	Description	Unit
IF65215	Bump-on Bs-33 Clear 12.7x3.8mm 200 pieces per sheet	Each

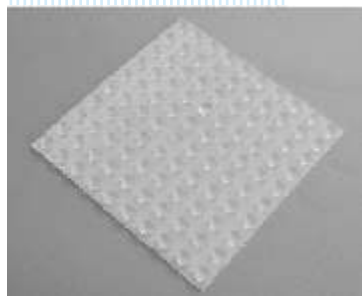

Stock Code	Description	Unit
IF65220	Bump-on Bs-35 Clear 9.5x4.8mm 200 pieces per sheet	Each



Stock Code	Description	Unit
IF65240	Bump-on White Foam 3mm 125 pieces per sheet	Each

Bump-ons

Group 3
3.3

>Connectors, Cable Caps & Castors

	Stock Code	Description	Unit
	IF65025	Bench Top Connector Plate Black Plastic	Each

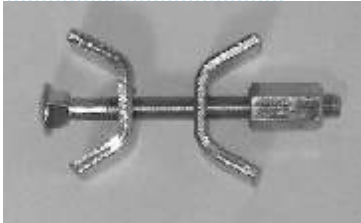
	Stock Code	Description	Unit
	IF65050	Bench Top Connector Metal 65mm	Each

	Stock Code	Description	Unit
	IF65055	Bench Top Connector Metal 150mm	Each

	Stock Code	Description	Unit
	IF65057	Bench Top Connector Holder for Standard Metal Connector IF65050	Each

	Stock Code	Description	Unit
	IF65060	Zip Bolt UT 85mm - 35mm <ul style="list-style-type: none"> • Eliminate the need for surface mounted worktop joining strips • The nut is tightened onto the bolt pressing the caps against the walls of the Ø 35 mm holes and pulling the two worktops or panels together • Can be tightened using cordless drill, spanner or hand tightened with a screwdriver 	Each

	Stock Code	Description	Unit
	IF65065	Zip Bolt UT Mini <ul style="list-style-type: none"> • Eliminate the need for surface mounted worktop joining strips • The nut is tightened onto the bolt pressing the caps against the walls of the Ø 35 mm holes and pulling the two worktops or panels together • Can be tightened using cordless drill, spanner or hand tightened with a screwdriver 	Each

>Connectors, Cable Caps & Castors



Stock Code	Description	Unit
IF65670	Connector Screw N.P. M4 x 15mm	Each



Stock Code	Description	Unit
IF65675	Connector Screw Sleeve M4 X 27mm	Each

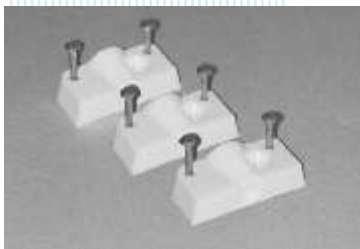

Stock Code	Description	Unit
IF65792	Fastener Black Quick Clip Connector	Each
IF65794	Fastener Beige Quick Clip Connector	Each
IF65796	Fastener Brown Quick Clip Connector	Each
IF65798	Fastener Grey Quick Clip Connector	Each
IF65800	Fastener White Quick Clip Connector	Each



Stock Code	Description	Unit
IF65810	Figure Eight Connector	Each



Stock Code	Description	Unit
IF65835	Flush Mount Mini ZP #1130	Each

>Connectors, Cable Caps & Castors



Stock Code	Description	Unit
IF66020	K.D. Fitting TZ20 Beige	Each
IF66025	K.D. Fitting TZ20 Black	Each
IF66030	K.D. Fitting TZ20 White	Each
IF66035	K.D. Fitting TZ20 Grey	Each
IF66040	K.D. Fitting TZ20 Dark Brown	Each
IF66045	K.D. Fitting TZ20 Light Brown	Each



Stock Code	Description	Unit
IF65300	Cable Entry Cap White 60mm	Each
IF65301	Cable Entry Cap Alpine Haze 60mm	Each
IF65302	Cable Entry Cap Silver Grey 60mm	Each
IF65303	Cable Entry Cap Dove Grey 60mm	Each
IF65304	Cable Entry Cap Graphite 60mm	Each
IF65305	Cable Entry Cap Grey 60mm	Each
IF65306	Cable Entry Cap Cream Beige 60mm	Each
IF65310	Cable Entry Cap Black 60mm	Each
IF65315	Cable Entry Cap Beige 60mm	Each



Stock Code	Description	Unit
IF65320	Cable Entry Cap White 80mm	Each
IF65322	Cable Entry Cap Silver Grey 80mm	Each
IF65325	Cable Entry Cap Grey 80mm	Each
IF65326	Cable Entry Cap Cream Beige 80mm	Each
IF65330	Cable Entry Cap Black 80mm	Each
IF65335	Cable Entry Cap Beige 80mm	Each
IF65338	Cable Entry Cap Dark Grey 80mm	Each

Connectors, Cable Caps & Castors
Group 3
3.4

>Connectors, Cable Caps & Castors



Stock Code	Description	Unit
IF65355	Castor 40mm Black Hooded - Spindle & Socket W/Brake	Each



Stock Code	Description	Unit
IF65370	Castor 40mm Black Hooded - Square Plate No Brake	Each



Stock Code	Description	Unit
IF65385	Castor 50mm Black Hooded - W/19mm U-channel Stem	Each



Stock Code	Description	Unit
IF65395	Castor 50mm Black Hooded - Square Plate No Brake	Each

>Connectors, Cable Caps & Castors



Stock Code	Description	Unit
IF65400	Castor 50mm Black Hooded - Spindle & Socket W/Brake	Each



Stock Code	Description	Unit
IF65442	Castor 75mm Black Wheel Silver - Square Plate W/Brake	Each



Stock Code	Description	Unit
IF65448	Castor 100mm Transparent / Black - Square Plate	Each



Stock Code	Description	Unit
IF65346	Castor 50mm PP White Rigid Plate	Each

Connectors, Cable Caps & Castors
Group 3
3.4

>Connectors, Cable Caps & Castors



Stock Code	Description	Unit
IF65348	Castor 50mm PP White Swivel Plate No Brake	Each



Stock Code	Description	Unit
IF65356	Castor 50mm Rubber Swivel Plate W/Brake	Each



Stock Code	Description	Unit
IF65357	Castor 50mm Rubber Swivel Plate No Brake	Each



Stock Code	Description	Unit
IF65371	Castor 80mm White Swivel W/Brake H/D 200KG	Each



Stock Code	Description	Unit
IF65372	Castor 80mm White Rigid H/D 200KG No Brake	Each

>Connectors, Cable Caps & Castors



Stock Code	Description	Unit
IF65373	Castor 80mm White Swivel H/D 200KG No Brake	Each



Stock Code	Description	Unit
IF65822	Plinth Bracket for ADJ Glide M10	Each



Stock Code	Description	Unit
IF65825	Plinth ADJ Glide Metal M10 X 80	Each









Stock Code	Description	Unit
IF65841	Glide ADJ Non Swivel 1/4 X 1	Each



Stock Code	Description	Unit
IF65842	Glide ADJ Non Swivel 3/8 X 1	Each

www.tekform.com.au

>Fittings General

	Stock Code	Description	Unit
	IF65889	Glide Black 25mm M6 x 25mm	Each
	IF65850	Glide Carpet Black 25mm	Each
	IF65855	Glide Carpet Black 38mm	Each
	IF65875	Glides Tack-on 16MM Beige	Each
	IF65880	Glides Tack-on 19MM Beige	Each
	IF66070	Mirror Movement Cheval No:134	Unit
	IF66080	Mirror Cnr Inside N.P. No:103	Unit

Fittings General

Group 3
3.5

www.tekform.com.au

>Fittings General

	Stock Code	Description	Unit
	IF66100	Mirror Clip N.P. NO:80	Each

	Stock Code	Description	Unit
	IF66090	Mirror Clip Clear Plastic 3mm	Each

	Stock Code	Description	Unit
	IF66095	Mirror Clip Clear Plastic 4mm	Each

	Stock Code	Description	Unit
	IF66190	Playground Clip HVP #60 ZP	Each

	Stock Code	Description	Unit
	IF66600	Wedges Furniture Plastic Brown	Each

Fittings General

Group 3
3.5

www.tekform.com.au

>Fittings General



Stock Code	Description	Unit
IF66720	Wood Joiner Biscuit No:0 - Box 1000 Pieces	Each



Stock Code	Description	Unit
IF66725	Wood Joiner Biscuit No:10 - Box 1000 Pieces	Each



Stock Code	Description	Unit
IF66730	Wood Joiner Biscuit No:20 - Box 1000 Pieces	Each



Stock Code	Description	Unit
T000505-877-001	KD20 white 5mm Hole Plug	100



Stock Code	Description	Unit
T001080-877-001	KD20 white 8mm Hole Plug	100



Stock Code	Description	Unit
IF9999	Built In Ironing Board for Drawers	Each

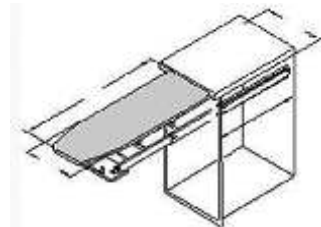
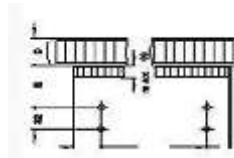

>Fittings General

	Stock Code	Description	Unit
	IF65072	Barrel Bolt Chrome 50mm	Each

	Stock Code	Description	Unit
	IF65087	Barrel Bolt Chrome 100mm - Necked	Each

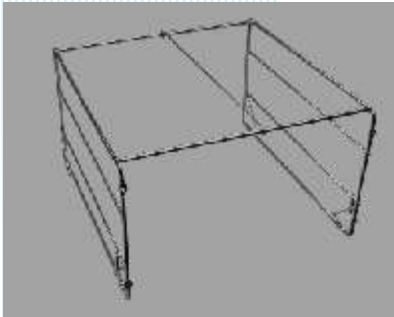
	Stock Code	Description	Unit
	DV14950	Filing Frame Set Chrome	Each

	Stock Code	Description	Unit
 (With Grommets)	IF66817	Centre Clip with Grommet - Plastic	Each

	Stock Code	Description	Unit
 (With Grommet)	IF66819	End Clip with Grommet - Plastic	Each

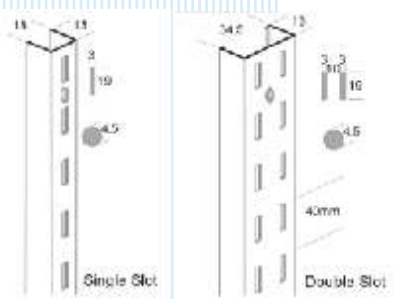
	Stock Code	Description	Unit
	IF66835	1200mm Single Strip White	Each
	IF66837	1500mm Single Strip White	Each
	IF66839	1800mm Single Strip White	Each
	IF66841	2100mm Single Strip White	Each
	IF66843	2400mm Single Strip White	Each
	IF66845	1200mm Double Strip White	Each
	IF66847	1500mm Double Strip White	Each
	IF66849	1800mm Double Strip White	Each
	IF66851	2100mm Double Strip White	Each
IF66853	2400mm Double Strip White	Each	

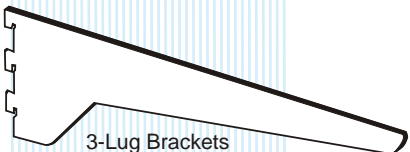
	Stock Code	Description	Unit
	IF66805	250mm White Bracket	Each
	IF66807	300mm White Bracket	Each
	IF66809	350mm White Bracket	Each
	IF66811	400mm White Bracket	Each
	IF66813	450mm White Bracket	Each
	IF66815	500mm White Bracket	Each



Stock Code	Description	Unit
T004375-835-001	KD15 Titus CD Racks - 20 LH Black	Each
T004376-835-001	KD15 Titus CD Racks - 20 RH Black	Each
T004488-835-001	KD15 Titus DVD Rack - 16 Pair Black	Pair

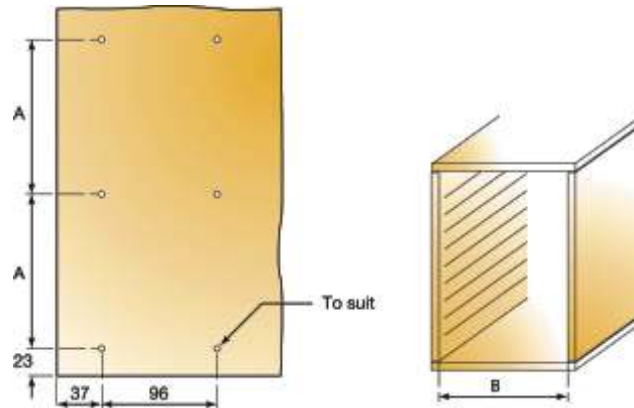

Stock Code	Description	Unit
T004435-861-001	KD15 Titus CD Grille 5mm S/PEG Silver	Each
T004437-835-001	KD15 Titus CD Grille 5mm G/PEG Black	Each

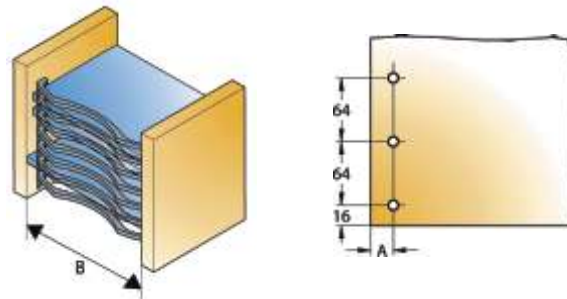

Stock Code	Description	Unit
T004611-835-001	KD16 Multifit 8 CD High Column Black	100
T004611-861-001	KD16 Multifit 8 CD High Column Silver	100

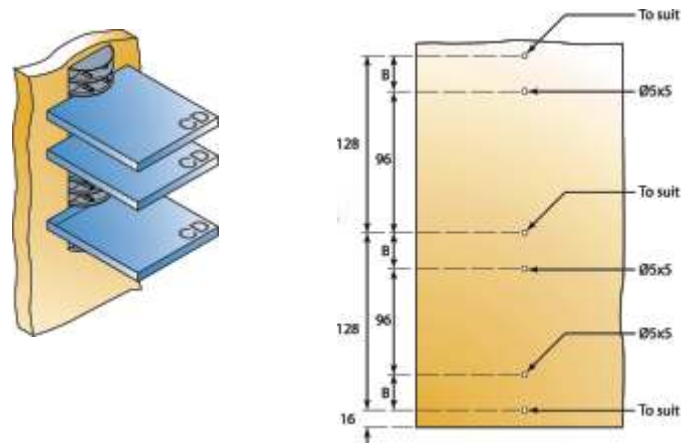



Stock Code	Description	Unit
T004637-835-001	KD15 Titus DVD Storage Column Black	Each
T004637-861-001	KD15 Titus DVD Storage Column Silver	Each
T004639-835-001	KD15 Black Cover Cap Suit 4637 Storage Column	Each
T004639-861-001	KD15 Silver Cover Cap Suit 4637 Storage Column	Each

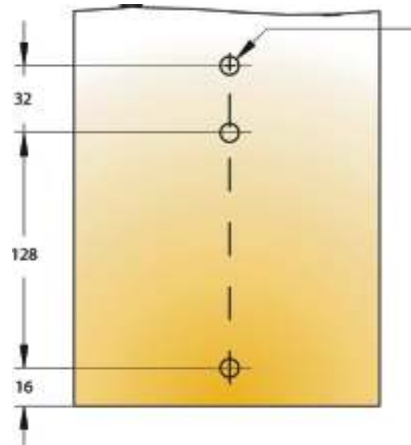
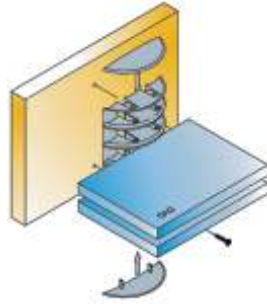



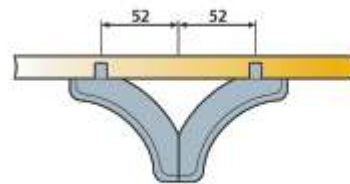
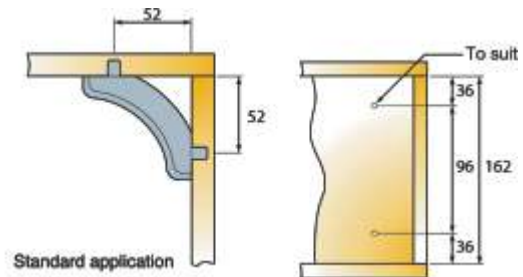
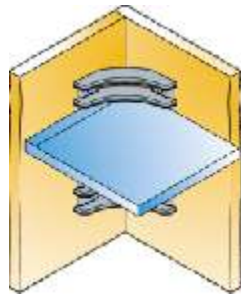



Stock Code	Description	Unit
T004645-835-001	KD15 Titus DVD Storage Corner Column Black	Each
T004645-861-001	KD15 Titus DVD Storage Corner Column Silver	Each



Back-to-back application

Overall height is 162 mm,
Repeat module is 180 mm.

>Shel f Supports

	Stock Code	Description	Unit												
	IF66200	Shelf Support Brass Bush 8mm	Each												
	IF66205	Shelf Support Brass Pin 8mm	Each												
	IF66210	Shelf Support Metal Pin White 5mm	Each		IF66220	Shelf Support Metal Pin Clear 5mm	Each		IF66225	Shelf Support Nail-on White	Each		IF66250	Shelf Support Steel Pin 16 x 5mm	Each
	IF66220	Shelf Support Metal Pin Clear 5mm	Each												
	IF66225	Shelf Support Nail-on White	Each												
	IF66250	Shelf Support Steel Pin 16 x 5mm	Each												

www.tekform.com.au

>Shel f Supports

	Stock Code	Description	Unit
	IF66245	Shelf Support N/P (15 X 20) 5mm	Each

	Stock Code	Description	Unit
	IF66259	Shelf Support W/PVC Cushion For Glass Shelf - 5mm	Each

	Stock Code	Description	Unit
	IF66258	Shelf Support Nickel Plated 5mm	Each

Shel f Supports

Group 3
3.6

> Sliding Door Tracks

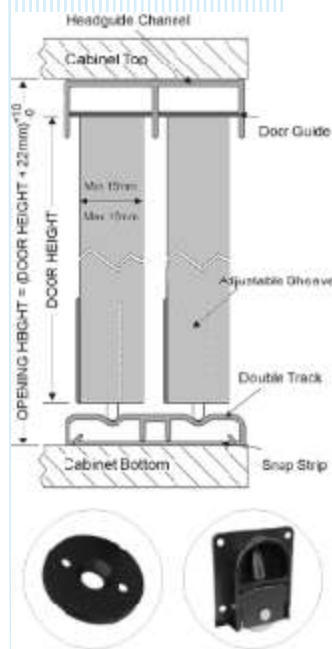

Stock Code	Description	Unit
IFP180	Cabinetmaker P180 Door Track - Set for 2 Doors 1200mm White	Each
IFP180A	Cabinetmaker P180 Door Track - Set for 2 Doors 1200mm White Nat Anod	Each
IFP180B	Cabinetmaker P180 Door Track - Set for 3 Doors 1500mm White	Each
IFP180C	Cabinetmaker P180 Door Track - Set for 3 Doors 1500mm White Nat Anod	Each
IFP180D	Cabinetmaker P180 Door Track - Set for 3 Doors 1800mm White	Each
IFP180E	Cabinetmaker P180 Door Track - Set for 3 Doors 1800mm White Nat Anod	Each

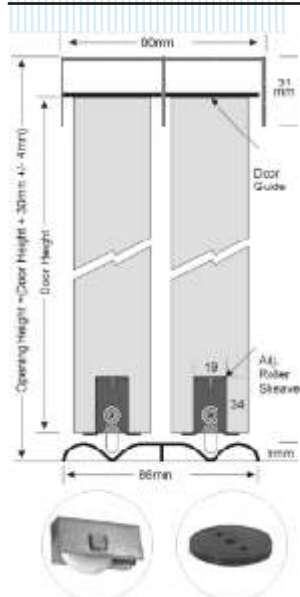

Stock Code	Description	Unit
IFP580	Robemaker P580 Door Track Set - For 2 Doors 1620mm Gloss White	Each
IFP580A	Robemaker P580 Door Track Set - For 2 Doors 1620mm Clear	Each
IFP580B	Robemaker P580 Door Track Set - For 3 Doors 2420mm Gloss White	Each
IFP580C	Robemaker P580 Door Track Set - For 3 Doors 2420mm Clear	Each
IFP580D	Robemaker P580 Door Track Set - For 4 Doors 3240mm Gloss White	Each
IFP580E	Robemaker P580 Door Track Set - For 4 Doors 3240mm Clear	Each